



## Technical Data Sheet OPUS A6 ECO Full





## 1 Notes and Warnings

### Attention!

This description is not a substitution for the concerned product's documentation. Please do read the documentation including the manuals carefully before dealing with this product. If the safety instructions in the documentation are not followed dangerous situation can occur that can result in damages, injuries and/or death by high voltage or wrong handling. In case you do not have the correct documentation, you can order it by contacting [opus-support@topcon.com](mailto:opus-support@topcon.com). Only properly trained personnel with the correct qualification is allowed to handle the device.

### Attention!

Do not open the housing to avoid danger to high voltage. Before touching the electric assemblies make sure that the electricity is switched off completely. If the front panel is broken the device needs to be taken out of service due to risk of injury. If perceivable damages on the device exist that can compromise the functionality, it must be taken out of service due to the danger of malfunctions. These particularly include damages to the LCD display, damages to the keyboard, damages that compromise the protection level and damages to the encoder knobs.

### Please note:

All content is subject to change without notice. Errors and omissions excepted.

### Mounting and Handling

1. Do not use the cable as a handle to carry the device.
2. Mounting in clean working environment only.
3. Do not mount the device under the use of violence because it can cause damage.
4. The device must be mounted by trained personnel only into especially designed and tested system.
5. The device may not be opened or disassembled.
6. The device is to be cleaned with a moist fuzz free cotton cloth. If necessary, a mild cleaning agent may be used. Do not use acid or abrasive cleaning agents.
7. The device is to be stored in a cool and dry environment and to be protected against sunshine.
8. If the environmental temperature is beneath 10°C the reaction time of the display increases.

## 2 General Information

### Order numbers

This documentation is valid for OPUS A6 Generation 2 order numbers as follows:

OPUSA6EN2CANF000    OPUSA6EN2CDSF000    OPUSA6EN2CWVF000

**OPUS Projektor**  
**CODESYS®**  
**CODESYS®**  
**with WebVisu**



## Dimensions

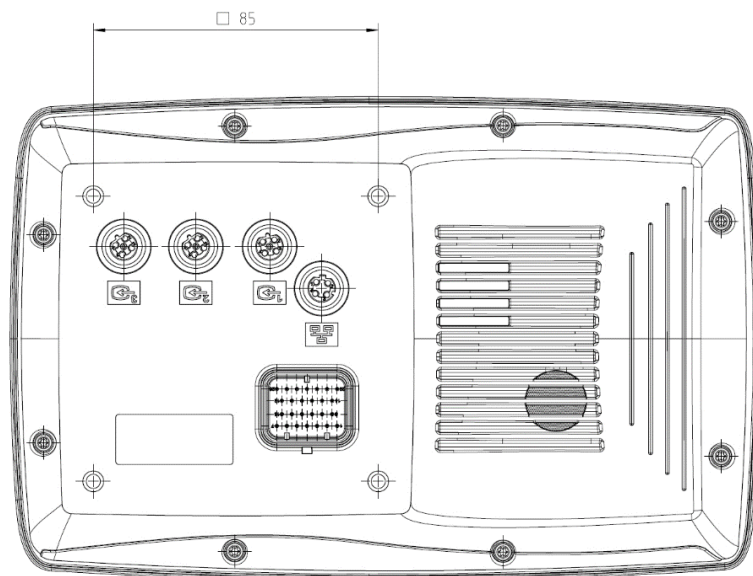
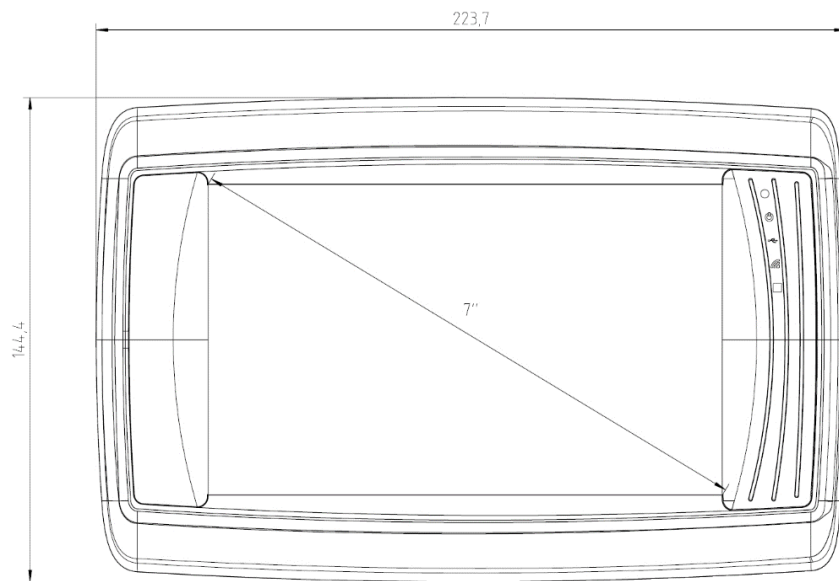
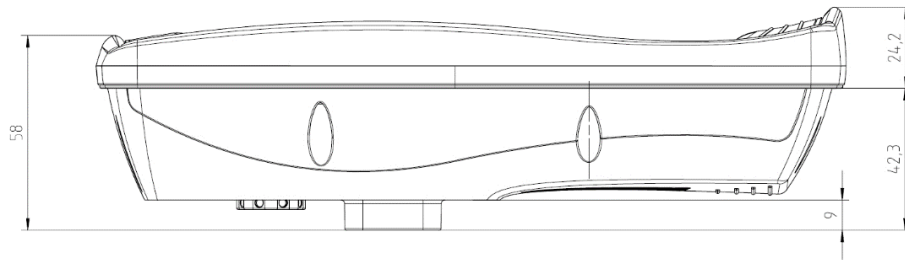

### Housing

Front cover: PC/ABS, colored light grey (RAL 7035) with black rubber frame.  
Back cover: aluminum die cast, colored light grey (RAL 7035)

### Mounting

- Landscape or portrait
- Standalone
- In-dash



### 3 Display

Type:	TFT Color Graphic LCD with LED backlight	Colors:	16.7 Mio.
Size:	7", 152 mm (W) x 91 mm (H)	Brightness:	typ. 500 cd/m <sup>2</sup>
Resolution:	800 x 480 px (WQVGA), 15:9	Contrast Ratio:	typ. 600:1

### 4 Input Devices

Touch	PCT
Indicators and Sensors	Light sensor 1 Multicolor LED 3 Status LEDs

### 5 Electronics

#### Processor platform

CPU:	Freescale I.MX6 <sup>®</sup> solo, 800 MHz
Mass storage:	4 GByte (minus space for OS & application)
RAM:	512 MByte
RTC:	Buffered by gold cap

Speaker	80 dB @ 1kHz in 1 m distance
---------	------------------------------

Operating frequency range	840 Hz to 6 kHz
---------------------------	-----------------

#### Power supply

System supplied through terminal 30 (battery +, see pinout) and 31 (battery -, see pinout).  
 Terminal 15 (ignition) to be used to switch on/off.  
 Operating voltage range: 9 ... 36 V DC.  
 Short circuit protection.  
 Over-voltage protection up to 48 V for max. 2 min.  
 Inverse polarity protection up to -48 V DC for max. 5 min.

#### Current consumption (without external load), max

Power Mode	Current at 13,5 V DC	Current At 27 V
On	≤ 1000 mA	≤ 600 mA
Low-power	Depending on configuration	
Sleep	≤ 100 mA	≤ 65 mA
Off	≤ 2 mA	≤ 2 mA



## 6 Interfaces

### CAN Bus

2 x CAN-Interface according to ISO 11898, CAN-specification 2.0 B active, up to 1 Mbit/s (default 250 Kbit/s, 500 Kbit/s, 750 Kbit/s, 1 Mbit/s)

---

### RS232

1 x RS232-Interface  
Type: EIA232 (only RXD, TXD, GND)  
Speed: max. 115 Kbps

---

### USB

Host 2.0  
Main connector: 1 x High speed

---

### Inputs

4 configurable analog/digital inputs  
Input impedance > 3k Ohm  
Resolution: 12 bit (1028 digits,  
1 digit = 11,7 mV)  
Voltage range: 0 ... 12 V  
Over-voltage protection: Up to 36 VDC  
Short circuit protection: Up to 36 VDC  
Frequency: Max. signal  
frequency 50 Hz  
Input 1 max. signal  
frequency 10 kHz

### Outputs

3 digital outputs  
Short circuit protection: up to 36 V  
 $I_{max}$  300 mA open drain  
 $R_{DS,on}$  < 1 Ohm  
 $R_{DS,off}$  > 100 kOhm

---

### Video Interface

Inputs: 3 x analog  
 $V_{ss}$  1 V  
Camera supply: 12 VDC  
Max. current: 500 mA

---

### Ethernet Interface

1 x 10/100 Mbit/s Base T

---

### Audio

1 Audio output (left, right, GND)  
AC97 compatible  
Output power approx. 65 mW @ 32 Ohm

## 7 Connectors

### Connectors

**Main** Typo-AMP 1437288-6  
Mating connector (customer)  
Typo-AMP 3-1437290-7  
Mating crimp contact (customer)  
Typo-AMP 3-1447221-4  
Dummy Plug (customer)  
Typo-AMP 4-1437284-3

**Video** M12 round connector, female,  
5-pole, B-coded, acc. To EN  
61076-2-101

**Ethernet** M12 round connector,  
female, 4-pole, D-coded,  
acc. To EN 61076-2-101

Recommended mating connector type according to  
IEC 61076-2-10: MM 004-Gx1-D  
x) A, C, I, P, R or S-type

Recommended mating connector type  
according to IEC 61076-2-10: MM 005-Gx1-B  
x) A, C, I, P, R or S-type



## 8 Software

Operating System                      Linux Kernel 3.0.0 or higher

---

Application Programming            • OPUS Projektor  
    • CODESYS 3.x  
    • C/C++

## 9 Testing and Verification

### CE-Compliance

*EU Directive 2014/30/EU (EMC) according to*

- *EN 12895*: Industrial Trucks – Electromagnetic compatibility
  - *EN 13309*: Construction machinery – Electromagnetic compatibility of machines with internal electrical power supply
  - *EN ISO 14982*: Agricultural and forestry machinery – Electromagnetic compatibility – Test methods and acceptance criteria
- 

### E1 – Type approval

*EU Directive ECE R 10.4*

---

### Protection Level (IP Code)

IP 65 and IP 66 according to *ISO 20653*: Road Vehicles – Degrees of protection (IP-Code) – Protection of electrical equipment against foreign objects, water and access

---

### Electrical

12 and 24V-Systems according to *ISO 16750-2*: Road Vehicles – Environmental conditions and testing for electrical and electronic equipment – Electrical Loads

- *ISO 15003*: Agricultural Engineering – Electrical and electronic equipment – Testing resistance to environmental conditions

### Mechanical

• *ISO 16750-3*: Road Vehicles – Environmental condition and testing for electrical and electronic equipment – Mechanical loads., Code L

• *ISO 15003*: Agricultural Engineering – Electrical and electronic equipment – Testing resistance to environmental conditions

- Mechanical Shock: Level 2
  - Random Vibration: Level 2
  - Sinusoidal Vibration: Level 2
- 

### Climate

• *ISO 16750-4*: Road Vehicles – Environmental conditions and testing for electrical and electronic equipment – Climatic Loads

- Operating Temperature Range: -30 ... + 65°C
- Storage Temperature Range: -40 ... +85°C

• *ISO 15003*: Agricultural Engineering – Electrical and electronic equipment – Testing resistance to environmental conditions



## 10 Pinout

Main connector pinout

Pin No.	Assignment	Description
1	VCC	supply voltage +; terminal 30
2	Ignition Input	ignition input; terminal 15
3	GND	supply voltage -; terminal 31
4	CarGND	Car GND
5	n.c.	not connected
6	n.c.	not connected
7	n.c.	not connected
8	CAN1H	CAN 1 high
9	CAN1L	CAN 1 low
10	CAN2H	CAN 2 high
11	CAN2L	CAN 2 low
12	USB_VCC	USB +5V supply
13	USB_GND	USB supply GND
14	USB_D-	USB data -
15	USB_D+	USB data +
16	RS232 RxD	RS232 receive data
17	RS232 TxD	RS232 transmit data
18	RS232 GND	RS232 GND
19	A/DI3	analog/digital input 3
20	A/DI1	analog/digital input 1
21	A/DI2	analog/digital input 2
22	A/DI4	analog/digital input 4
23	SERV_EN	service enable
24	DO3	digital output 3
25	DO1	digital output 1
26	DO2	digital output 2

View on rear side of the OPUS A6

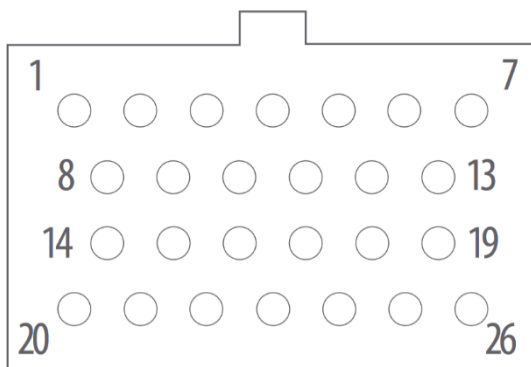



OPUS displays in the industrial sector are only intended to be used with cable length less than 30 meters.

### Video connector pinout

Round connector, 5 pins, M12	
1	VidSig+
2	n.c.
3	Camera+
4	Camera-
5	VidSig GND

### Ethernet connector pinout

Round connector, 4 pins, M12 acc. to IEC 61076-2-101	
1	TD+
2	RD+
3	TD-
4	RD-

Video connector, M12, female, 5 pins, b-coded,  
View on rear side of the OPUS A3

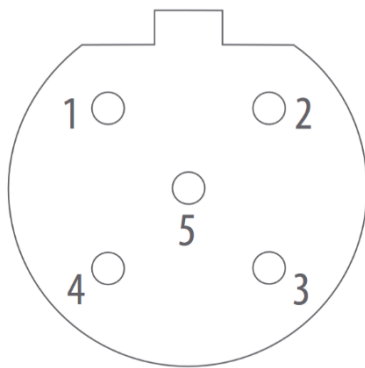

Ethernet connector, M12, female, 4 pins, d-coded,  
view on rear side of the OPUS A3

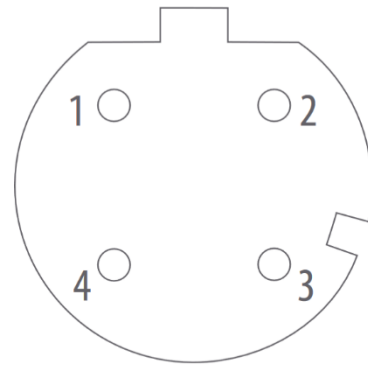

Recommended mating connector type according to IEC 61076-2-10:  
MM 005-Gx1-B  
x) A, C, I, P, R or S-type

Recommended mating connector type according to IEC 61076-2-10:  
MM 004-Gx1-B  
x) A, C, I, P, R or S-type





## 11 Accessories (not included)

Standalone mounting adaptor for RAM® mounting system (OPUSA6ZBAH001)

Material	PC+ABS
Dimensions	74x84x42xmm (WxHxD)
Operating temperature	-30 ... + 75 °C
Storage temperature	-40 ... + 85 °C
Max mounting torque	2.5 ± 0.2 Nm



Mounting kit (RAM® Mount 1,5", adapter cover) (OPUSBEM006)

- 1 x RAM® – 101 U
- 1 x Adapter for RAM® mounting system
- 7 x cylinder head bolt M5x12 DIN 912

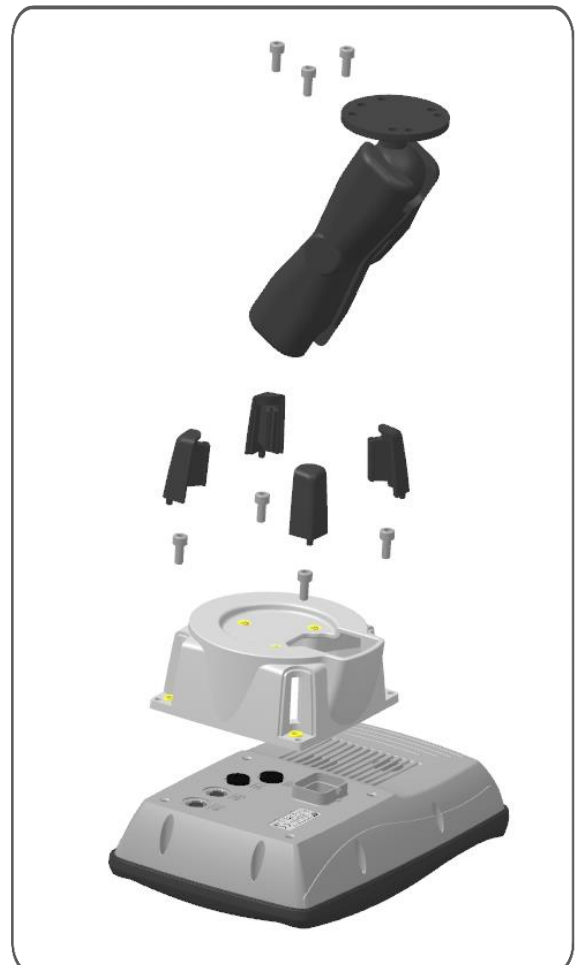



### In-Dash mounting frame (OPUSA6ZBEB002)

Material	PC+ABS
Dimensions	144x101x35 (WxHxD)
Operating temperature	-30 ... + 75 °C
Storage temperature	-40 ... + 85 °C
Max mounting torque	2.5 ± 0.2 Nm

Delivery includes highlighted parts only.  
Please follow the instruction for in-dash mounting.



### 26 pin connector, contact pins, dummy plugs (OPSVF26001)

